

**HUM ELIT OIL**

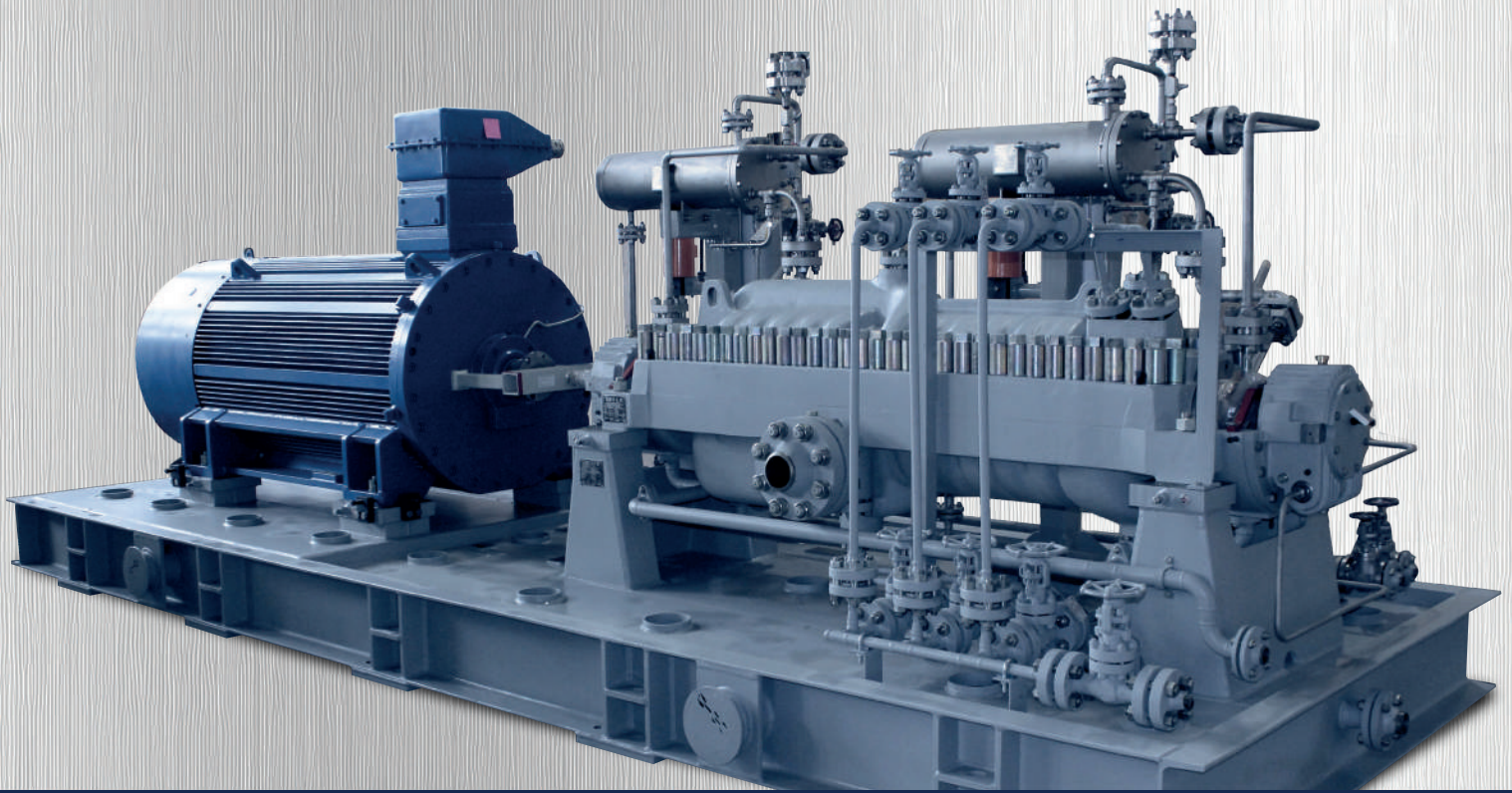

**CENTRIFUGAL  
PUMPS**





**HUM ELIT OIL**

# CENTRIFUGAL PUMPS

Licensed by  
JSC "NASOENERGOMASH SUMY"

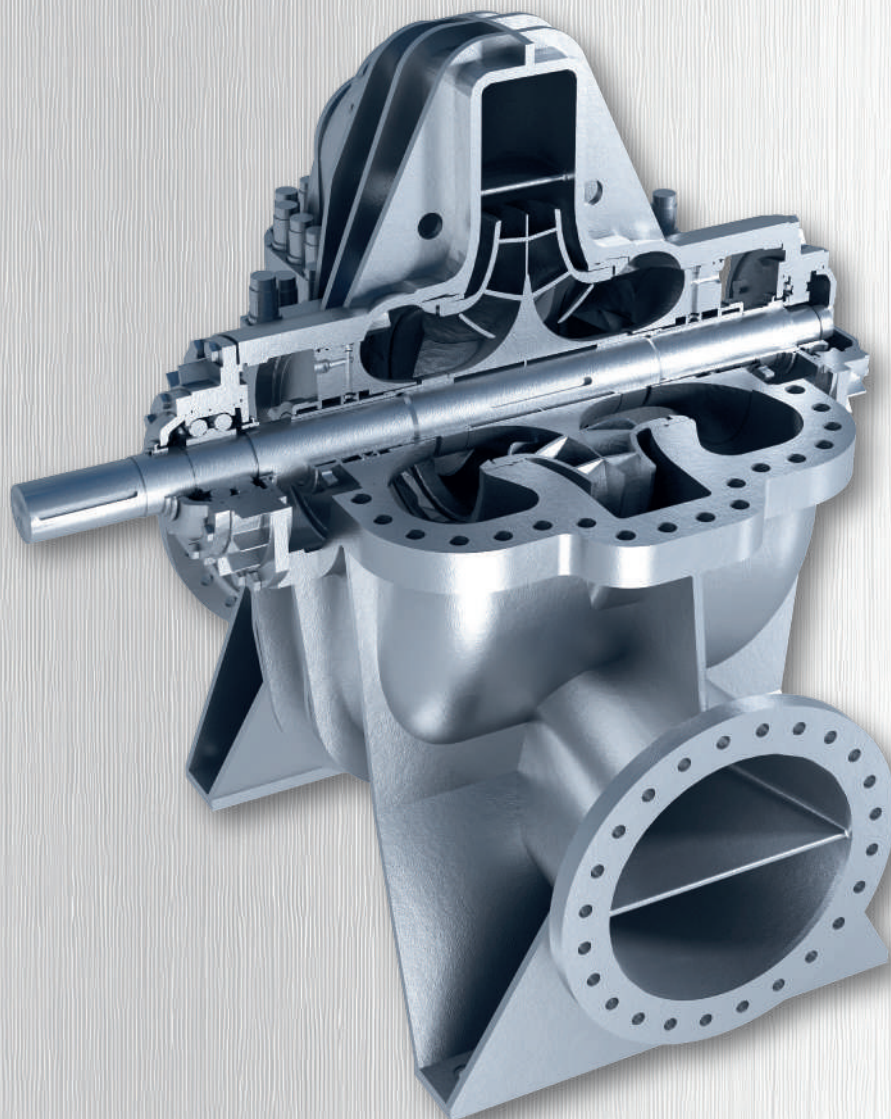

## Model: Desum

### Type: BB1

Design: centrifugal, foot-mounted, between-bearings, in-line, single-stage, double-suction, axially split volute casing, heavy-duty industrial pumps with a basically horizontal shaft. Available with optional vertical mounting (DV-configurations). Accurate positioning of the upper-to-lower casing halves with pins for ease of assembly.

The rotor is carried by grease-lubricated or oil-bath lubricated antifriction bearings (in the latter case a cooling system is provided). Shaft sealing: packed glands or API 682 single / double mechanical seals. Nozzle flanges are made according to DIN / ANSI / ISO. The pump shaft is completely protected against handled medium.



# Application: Water supply. Thermal power generation. Oil and Refinery

Pos.	Pump model	Rated flow m <sup>3</sup> /hr	Head, m	Rotational speed, rpm
1	D(DV) 350-580	2 850	105	1 500
		2 500	110	1 500
2	D(DV) 350-725d	2 900	180	1 500
		2 500	180	1 500
3	D(DV) 400-660	4 300	140	1 500
		2 850	60	1 500
		2 150	36	750
4	D(DV) 400-990	3 200	130	1 000
		2 700	100	1 000
5	D(DV) 500-735	4 400	75	1 000
		3 600	70	1 000
6	D(DV) 500-875	5 000	110	1 000
7	D(DV) 500-875A	6 000	105	1 000
8	D(DV) 500-875B	5 000	100	1 000
		4 000	110	1 000
9	D(DV) 500-1050	4 000	160	1 000
		3 500	140	1 000
10	D(DV) 600-720	5 900	70	1 000
		4 500	40	750
		3 500	40	750
		4 000	40	750
11	D(DV) 700-1000A	9 700	120	1 000
		8 500	115	1 000
12	D(DV) 700-1000B	7 400	40	600
		8 000	72	750
13	D(DV)700-700	7 400	72	750
		8 500	27	750
		7 250	27	750

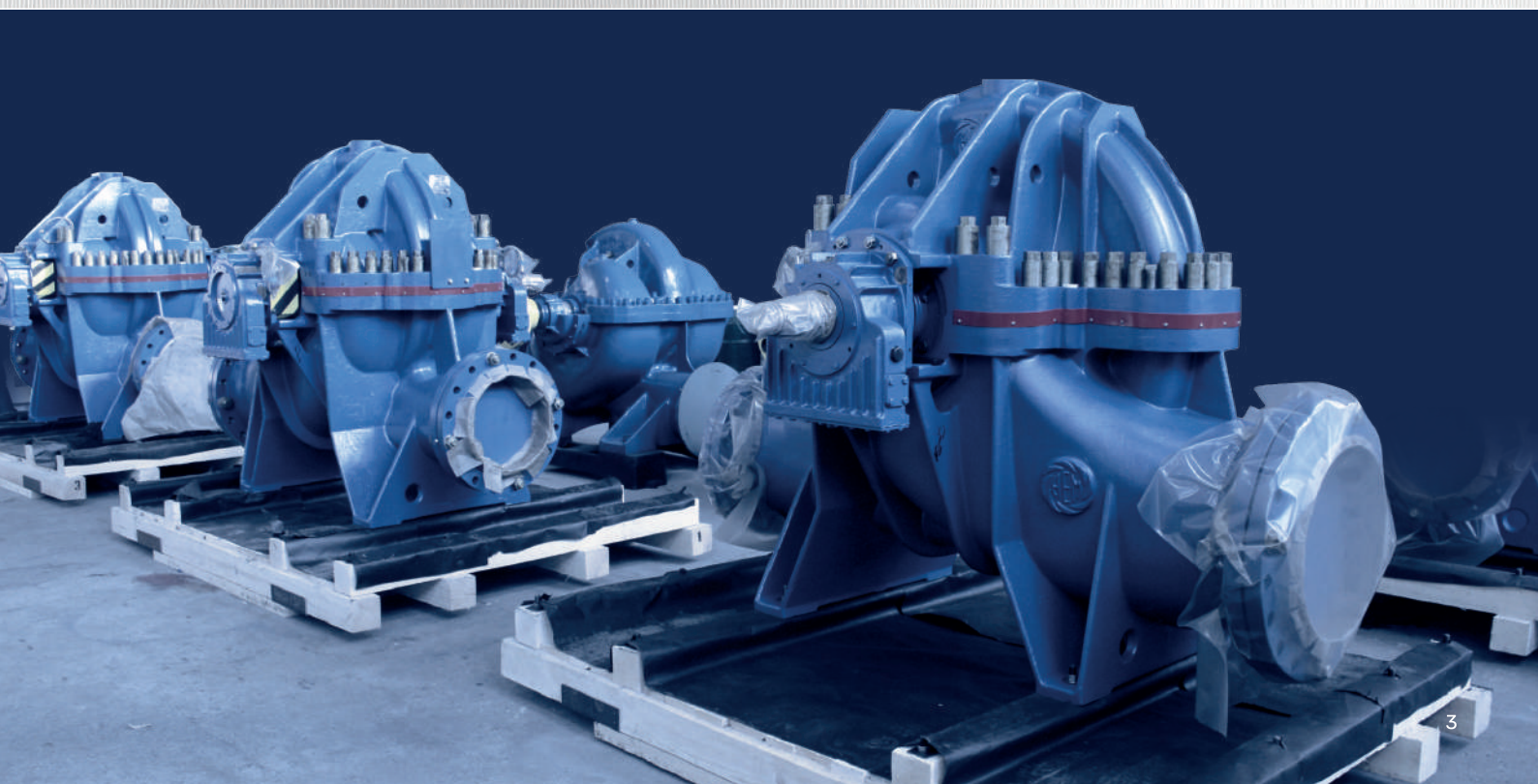
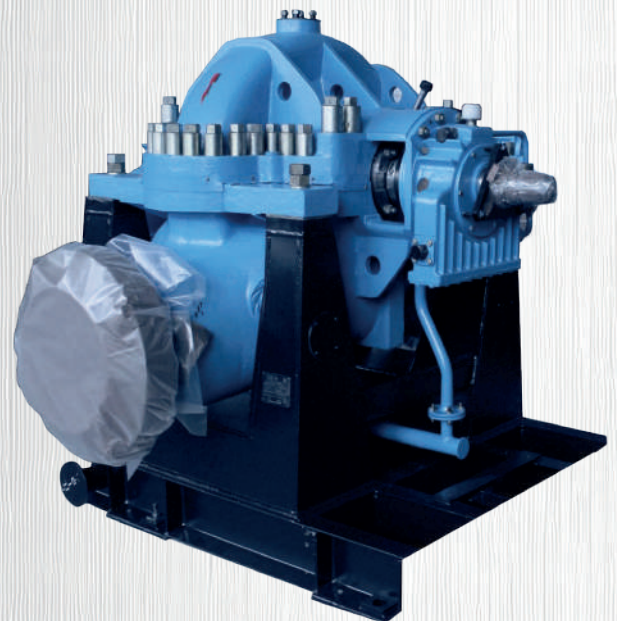



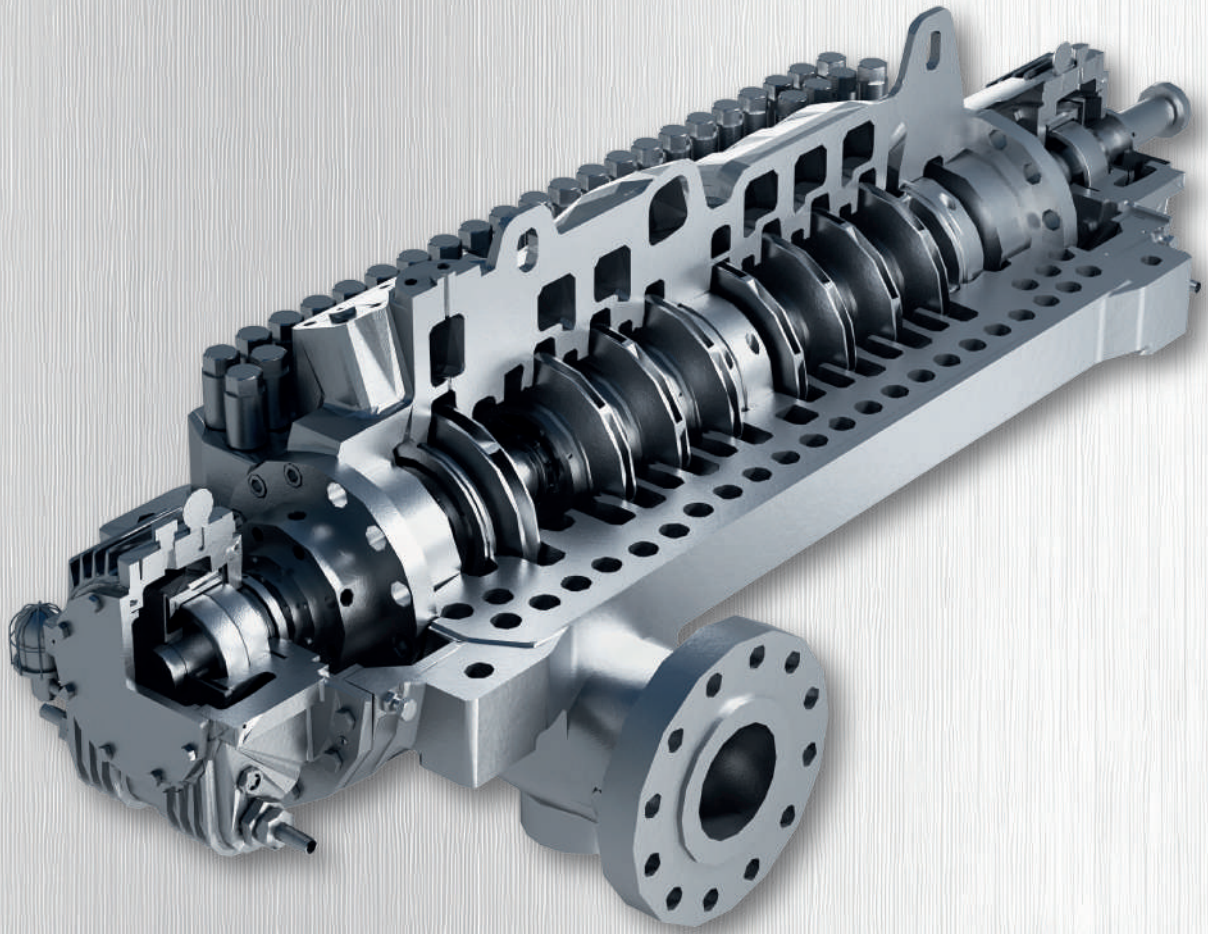

# Model: AMG.

## Type: BB3

**Design:** horizontal, centrifugal, multistage, between bearings, axial split casing pumps. The rotor is carried by friction bearings. Shaft sealing: API 682 single / double mechanical seals. Nozzle flanges are made according to DIN / ANSI / ISO.



# Application: Thermal power generation. Oil and Refinery

Pos.	Pump size	Flow part range	Flow, m <sup>3</sup> /hr	Head, max, m	Head, min. m	Rot. speed, rp/m
1	AMG 80	Min	40	1300	200	3 000
		Max	130	1300	200	3 000
2	AMG 100	Min	140	1500	200	3 000
		Max	270	1500	200	3 000
3	AMG 150	Min	300	1500	250	3 000
		Max	550	1500	250	3 000
4	AMG 200	Min	600	1300	250	3 000
		Max	850	1300	250	3 000
5	AMG 250	Min	900	1200	250	3 000
		Max	1500	1200	250	3 000

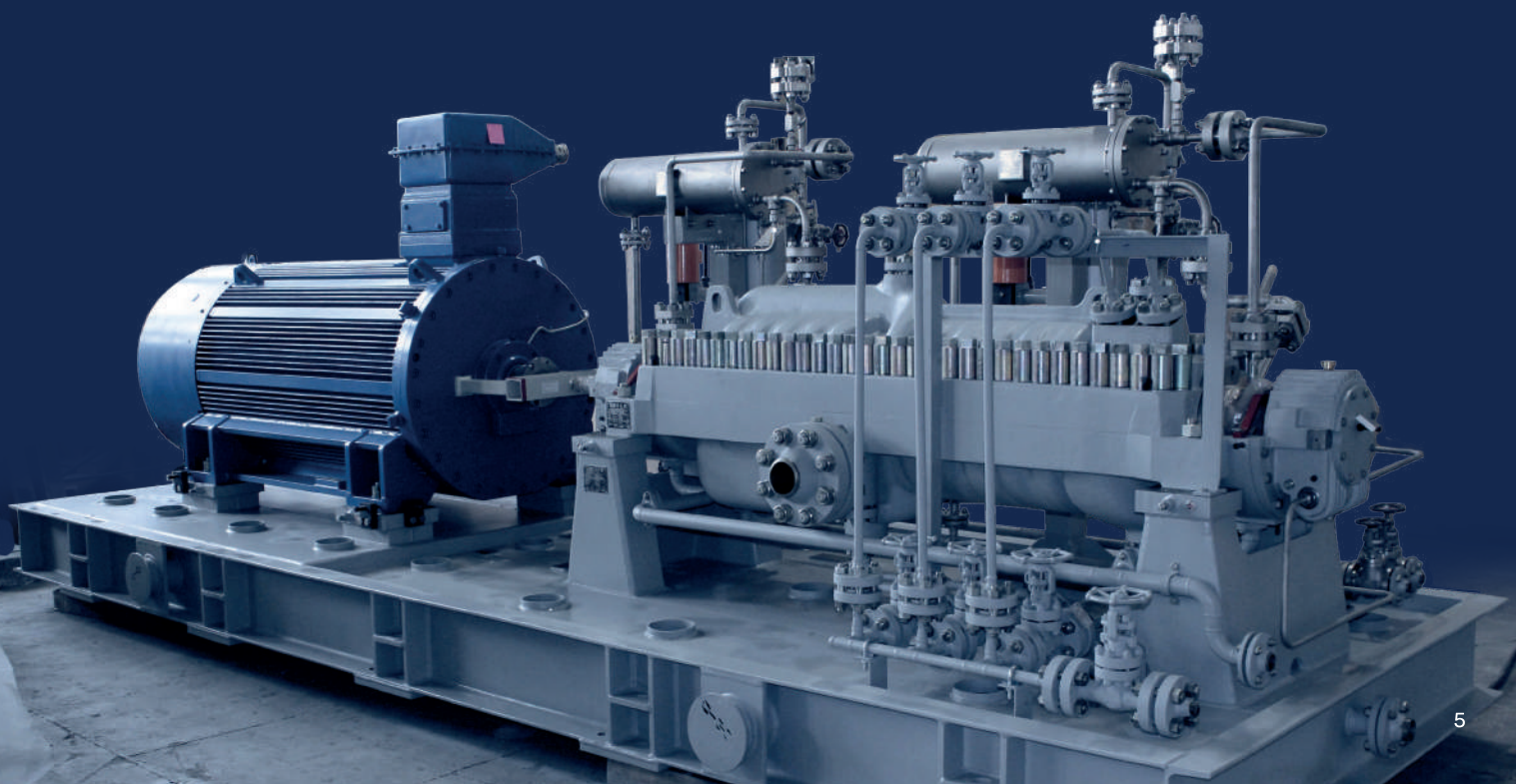
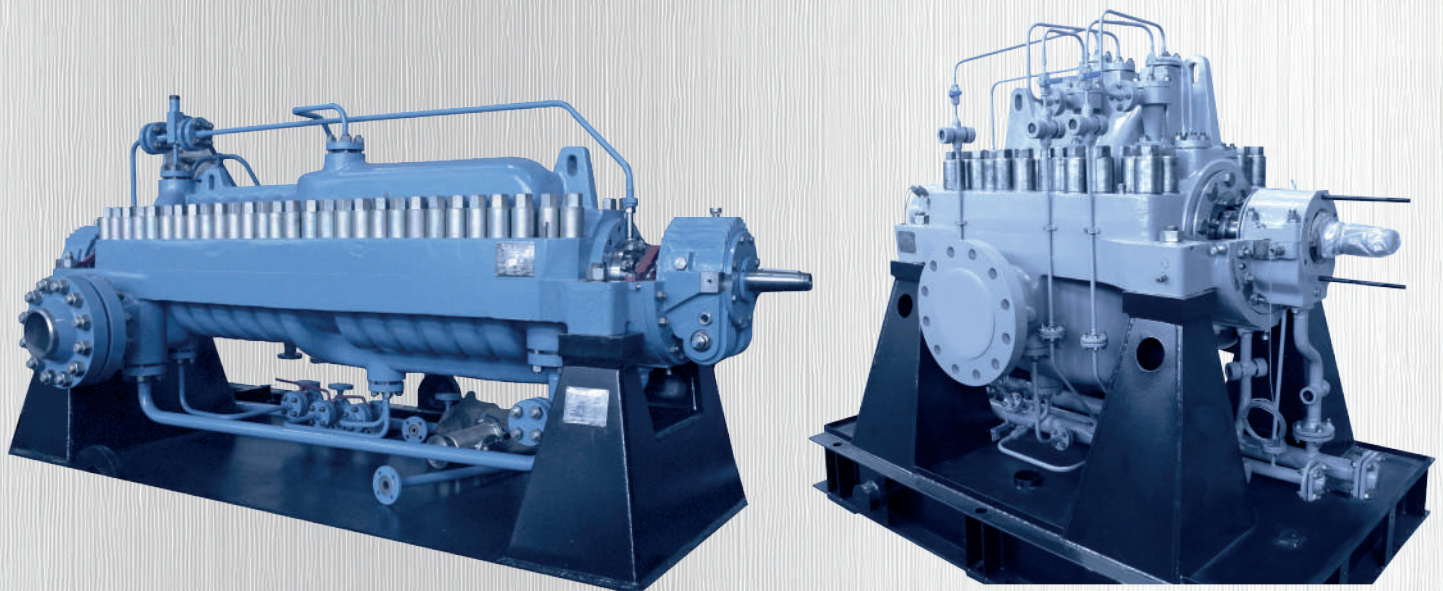



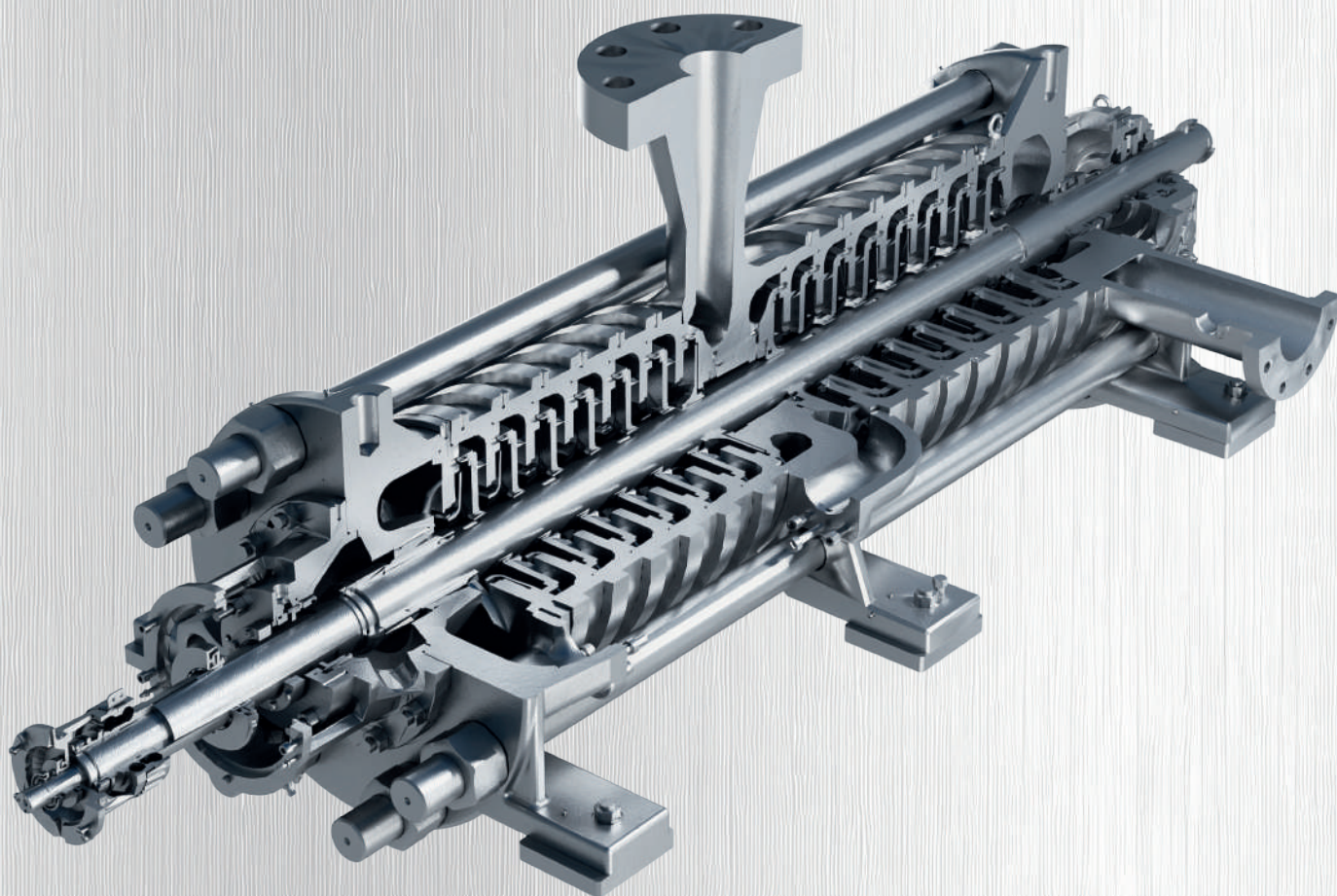

# Model: UHC, UHCn HP, GP

## Type: BB4

**Design:** UHC (CNS) pumps – centrifugal, horizontal, multi-stage, single-casing, sectional type

**Basic design UHC...-2:** the pump rotor is carried by the oil-bath or pressure oil lubricated sleeve bearings. Shaft sealing: soft packed glands (C) or mechanical seals (T). The suction nozzle horizontally sideward, the discharge nozzle vertically to the top. Axial thrust balancing – automatically device (balancing disc).

**Optional design UHCn...-2:** With back-to-back impeller arrangement that makes an axial thrust balancing device unnecessary in the pump design

and significantly improves the reliability of pump operation. The residual axial thrust is absorbed by a thrust bearing.

**Optional design UHC...-3:** the pump rotor is carried by the medium-lubricated plain bearings. Shaft sealing: soft packed glands (C) or mechanical seals (T). The suction nozzle horizontally sideward, the discharge nozzle vertically to the top.

**HP, GP pumps are multistage centrifugal pumps of a new generation, designed to replace CNS and CNSp pumps**



# Application: Water injection (upstream), oil handling, descaling pumps

Pos.	Pump size	Rated flow, m <sup>3</sup> /hr	Head, min, m	Head, max, m
1	UHC 10	10	200	600
2	UHC 30	30	500	1 250
3	UHC 45	45	600	2 100
4	UHC 90	90	600	2 100
5	UHC 120	120	600	2 100
6	UHC 180	180	600	2 100
7	UHC 200	200	600	2 200
8	UHC 240	240	600	2 100
9	UHC 315	315	600	2 200
10	UHC 360	360	1 400	2 300
11	UHC 500	500	1 000	2 200
12	UHC 630	630	1 000	2 200
13	UHC 720	720	1 000	2 200
14	UHC 280	280	600	1 200
n=3 000 rpm				
	UHC 180	180	70	500
	UHC 315	315	120	750
n=1 500 rpm				

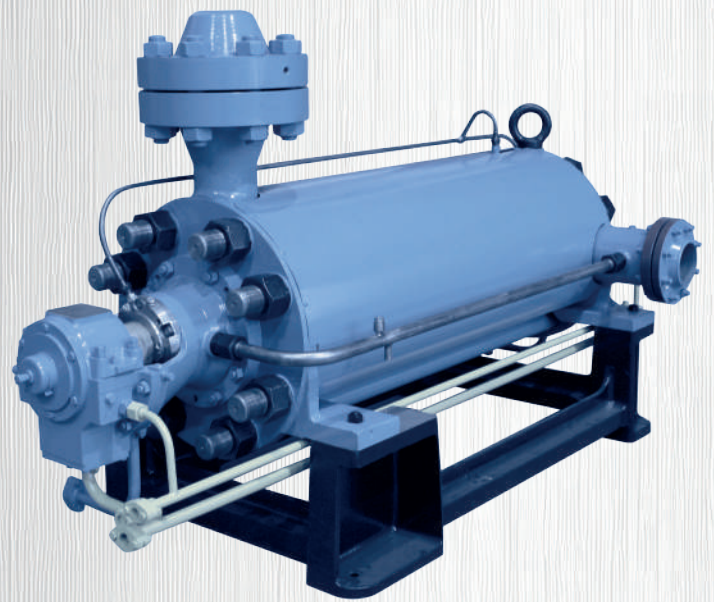
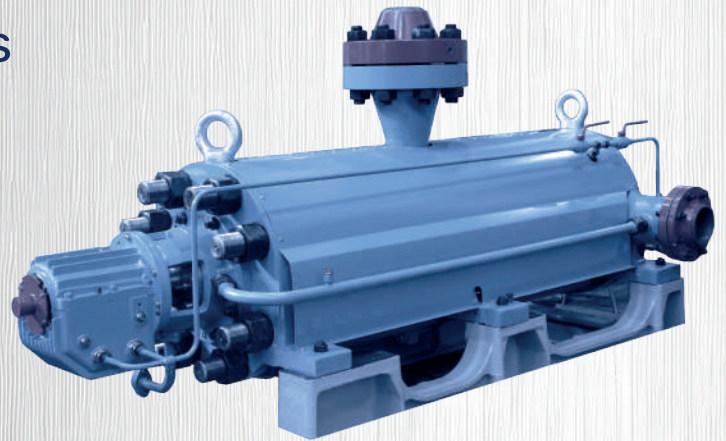



**Application: Downstream.  
Oil, Refinery, Chemicals;  
Sugar production**

No	Rated flow, m <sup>3</sup> /hr	Hmin, m	Hmax, m
1	5	18	60
2	15	15	150
3	30	15	160
4	50	15	160
5	75	15	160
6	100	15	180
7	150	15	210
8	200	15	160
9	300	20	180
10	400	20	150
11	500	30	150
12	600	30	150

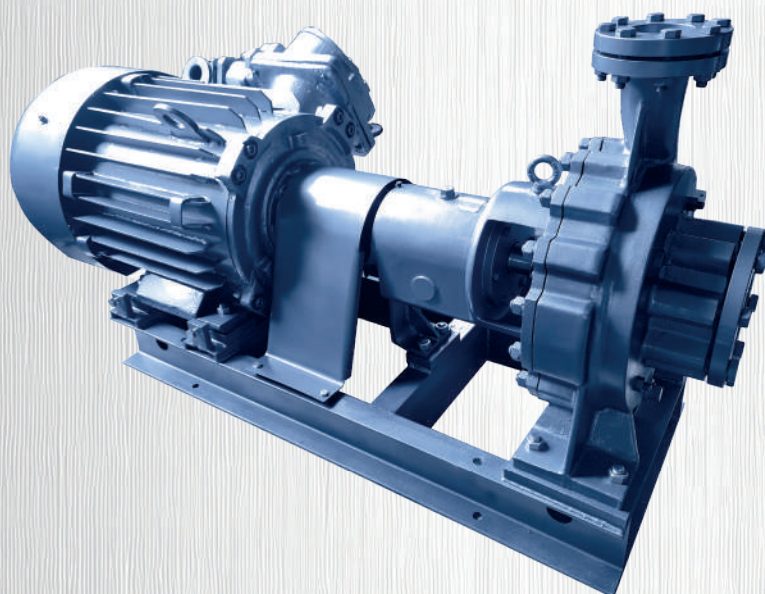
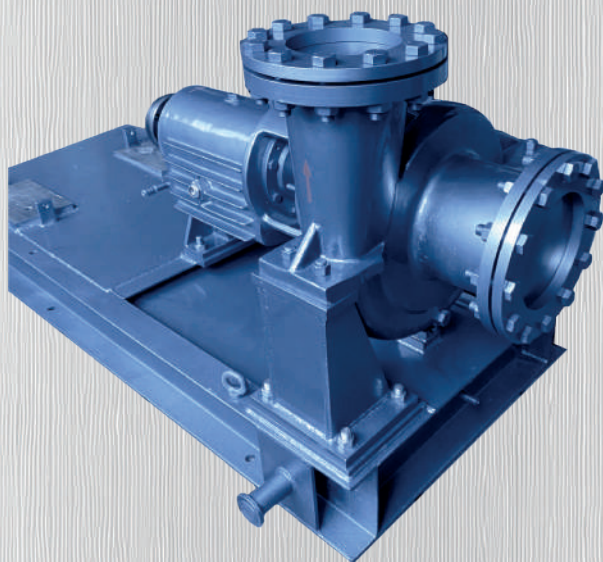
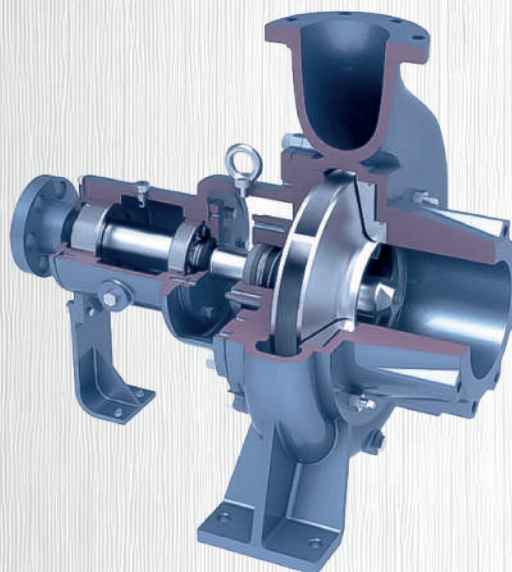

# Model: LC, NK

## Type: OH1/OH2

**Design:**

horizontal end-suction single-stage volute casing centrifugal pumps with overhung impeller and bearing bracket; feet mounted or centerline-mounted.

Shaft seal - at customer's choice: single mechanical, double mechanical, dynamic, gland.

**Design option:** optimized-NPSH impeller design with blades extending well into the suction chamber, inducer.

**Adjustable armored disc.**

The armored disk protects the body from wear, as well as when arranged with open impeller, allows you to adjust the gap between impeller and armored disk.

Enclosed impeller (high efficiency) or opened impeller (abrasive solid and slurry).



## Application: Boiler Feed Water Pumps (HP and LP)

No	Rated flow, m <sup>3</sup> /hr	Hmin, m	Hmax, m
1	35	40	220
2	60	40	580
3	90	600	1900
4	120	600	1900
5	150	300	1900
6	180	600	1900
7	240	600	1900
8	270	1200	1600
9	315	800	2100
10	380	1200	2300
11	500	1200	2300
12	580	1200	2300
13	720	1200	2000
14*	600	3000	3700*

\* pos. 14 - rot speed - 6300rpm  
pos. 1-13 - rot speed - 3000rpm.

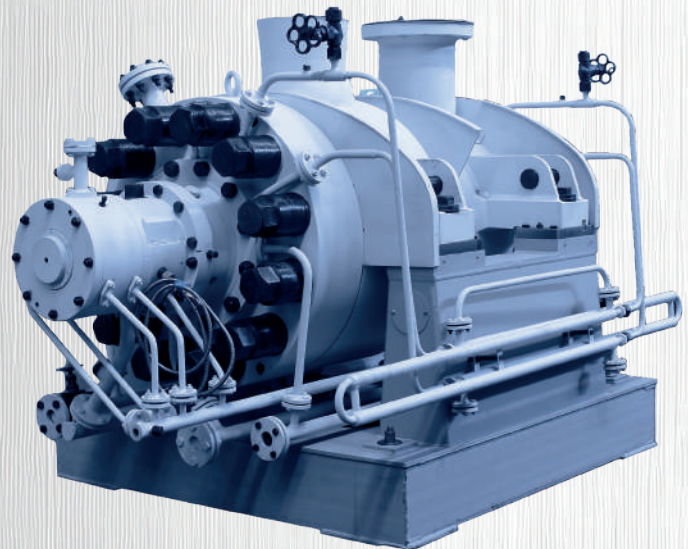
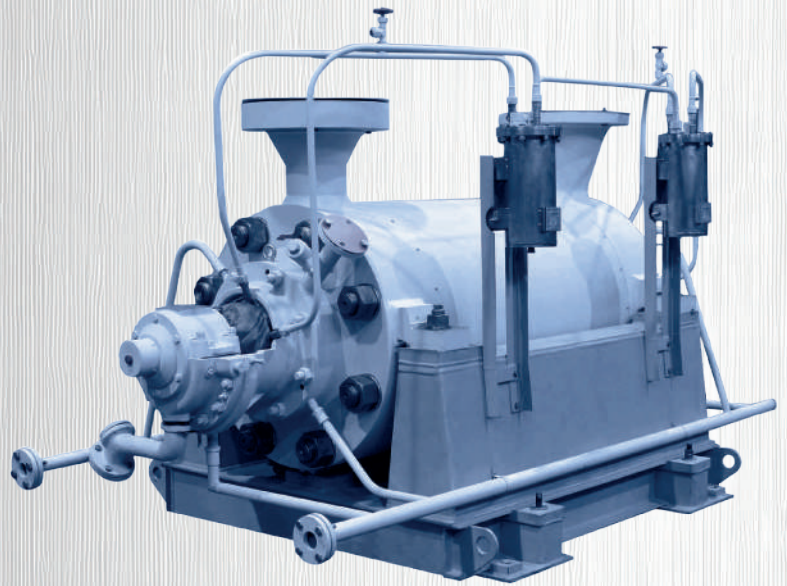

# Model: PE

## Type: BB4/BB5

**Design:** horizontal multistage diffuser centrifugal pumps of ring-section or barrel type with a withdrawable cartridge type. Single flow impeller arrangement, with all the impellers facing the same way. May be operated both at the constant and variable speed of rotation. The pump rotor is carried by the oil-ring or pressure lubricated sleeve bearings. Shaft sealing: packed glands or mechanical seals.

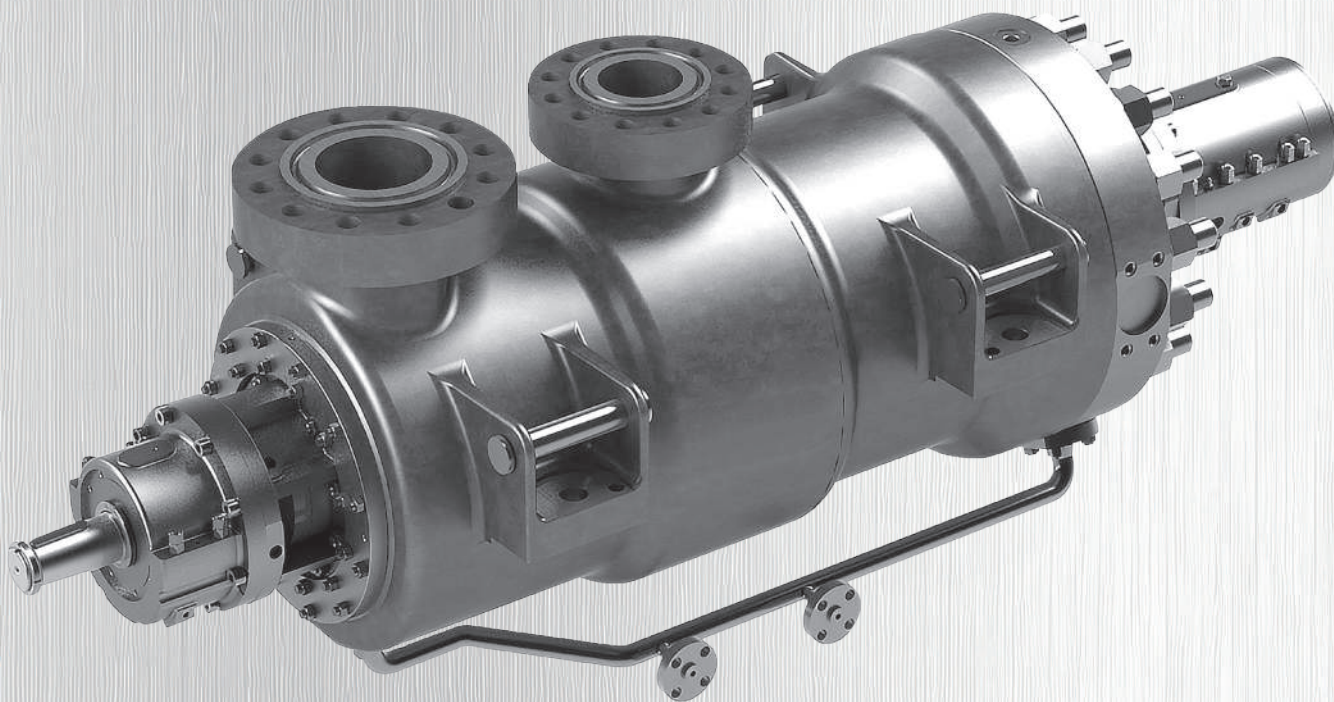

## Model: UHCDn, TG. TL

### Type: BB5

**Design:** UHCDn pumps are horizontal, double-casing, radially split, multistage, between-bearings pumps of a BB5 type (barrel pumps), in full compliance with ANSI/API standard 610 (ISO 13709:2009).

**TL, TG** models pumps are new generation double-casing (barrel), multi-stage centrifugal pumps with cartridge-type internal casing, designed in accordance with the requirements of international industry standards;

TL – impellers placed in series (one-by-one),  
TG – impellers placed opposite (back-to-back).  
The most powerful models develop pressure up to 2300m. A special flow part with a double-suction first-stage impeller provides a low NPSHr, which significantly expands the use of the pump and ensures cavitation-free operation with minimal capital costs on site.



# Application: Water injection (upstream), descaling pumps, Refinery

No	Rated flow, m <sup>3</sup> /hr	Hmin, m	Hmax, m
1	10	200	600
2	30	500	1250
3	45	600	2100
4	90	600	2100
5	120	600	2100
6	180	600	2100
7	200	600	2200
8	240	600	2100
9	310	600	2200
10	360	1400	2300
11	500	1000	2200
12	630	1000	2200
13	720	1000	2200
14	800	600	2300

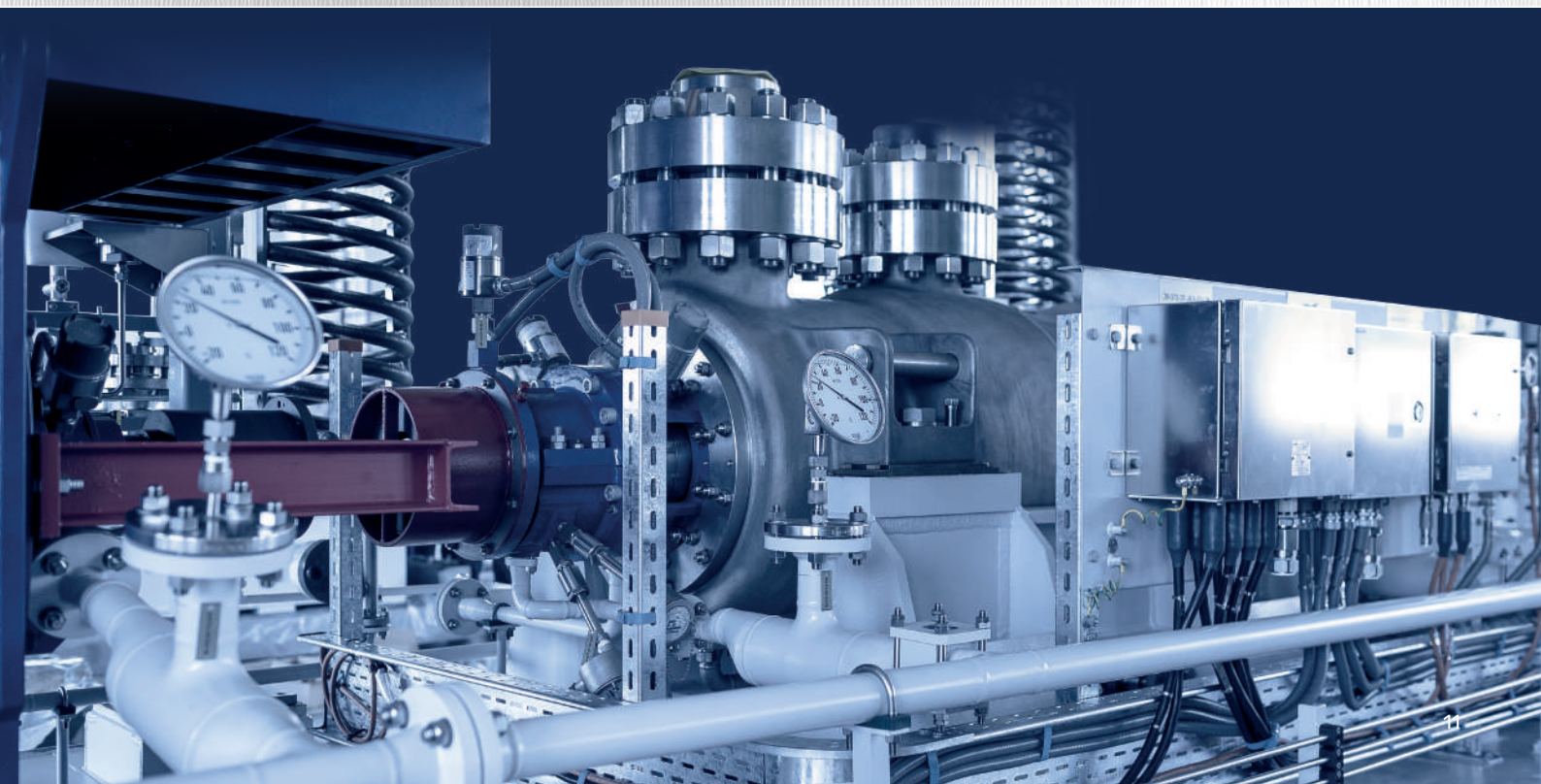
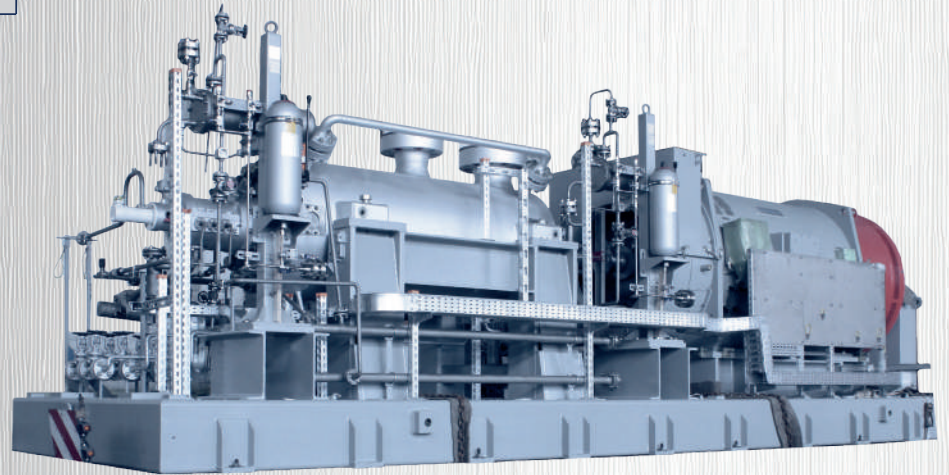
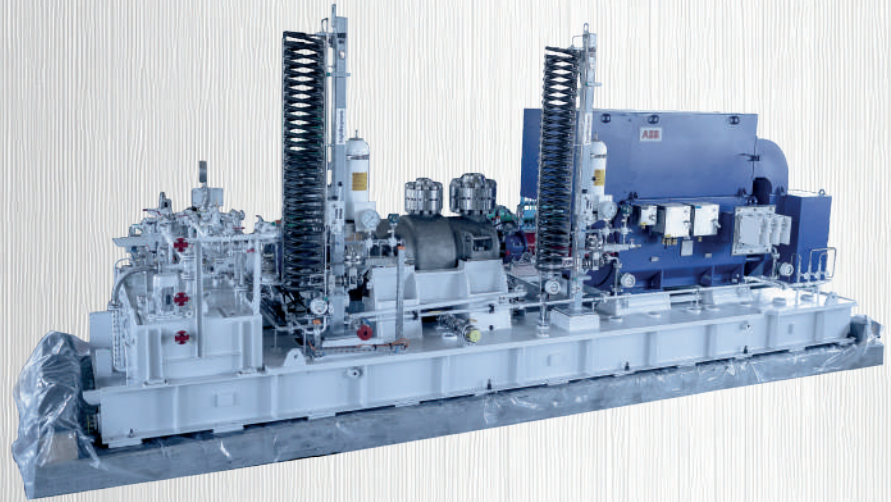



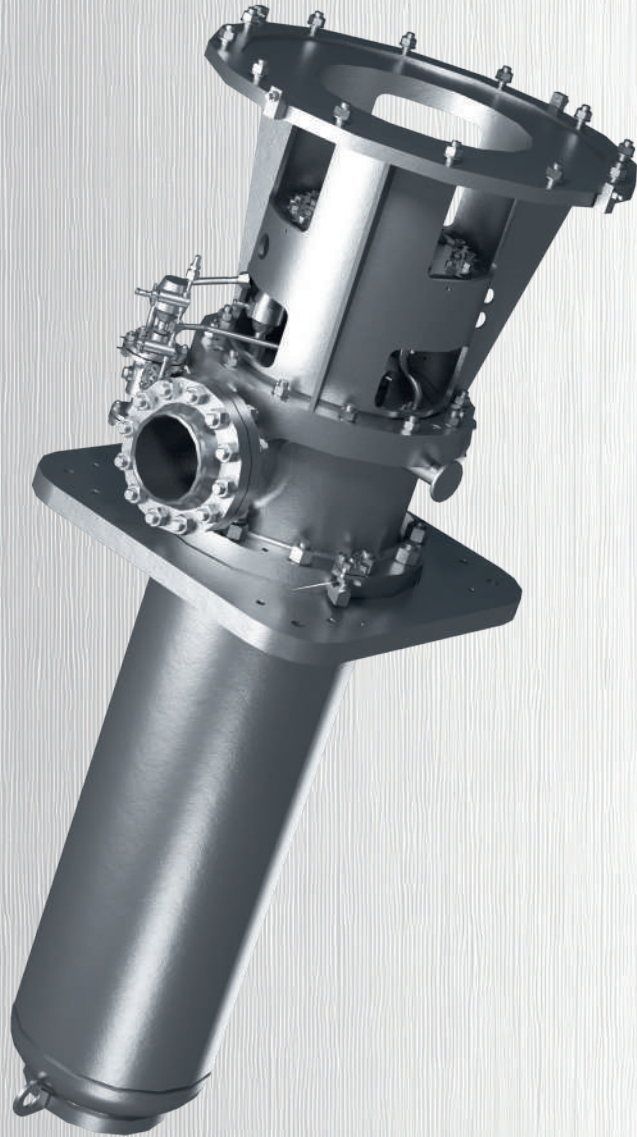

# Model: KsV, KsV-M, NPV, NMV

## Type: VS6/7

**Design:** vertically suspended, in-line, can, end-suction multistage diffuser centrifugal pumps with the first stage single or double flow impeller, provided with inducers. The pump rotor is carried by the top thrust and radial antifriction bearing and the bottom medium lubricated hydrodynamic plain bearing. Shaft sealing: by mechanical seal or gland seal. Designed in compliance with API Standard 610 requirements.



# Application: Condensate Extraction Pumps. Oil Booster Pumps.

No	Pump size	Rated flow, m <sup>3</sup> /hr	Hmin, m	Hmax, m
1	KsV 90	90	100	250
2	KsV 125	125	40	150
3	KsV 200	200	100	250
4	KsV 320	320	80	180
5	KsV 500	500	70	230
6	KsV 650	650	100	200
7	KsV 700	700	120	220
8	KsV 1000	1 000	80	100
9	KsV 1200	1 200	40	60
10	KsV-M 200	200	70	300
11	KsV-M 315	315	90	300
12	KsV-M 500	500	100	315
13	KsV-M 800	800	100	320
14	NPV 300	300	40	160
15	NPV 600	600	40	120
16	NPV 1250	1 250	30	90
17	NPV 2500	2 500	30	130
18	NPV 3600	3 600	30	140
19	NPV 5000	5 000	30	120
20	NMV 200	200	75	300
21	NMV 315	315	90	300
22	NMV 500	500	105	315
23	NMV 800	800	120	320
24	NMV 1250	1 250	110	330

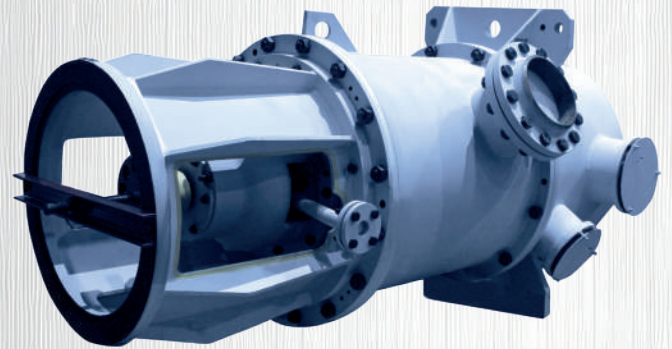

Application: Downstream.  
Oil, oil products,  
chemicals.

No	Rated flow, m <sup>3</sup> /hr	Hmin, m	Hmax, m
1	5	30	350
2	12,5	30	800
3	25	30	600
4	40	30	700
5	50	15	600
6	80	15	350

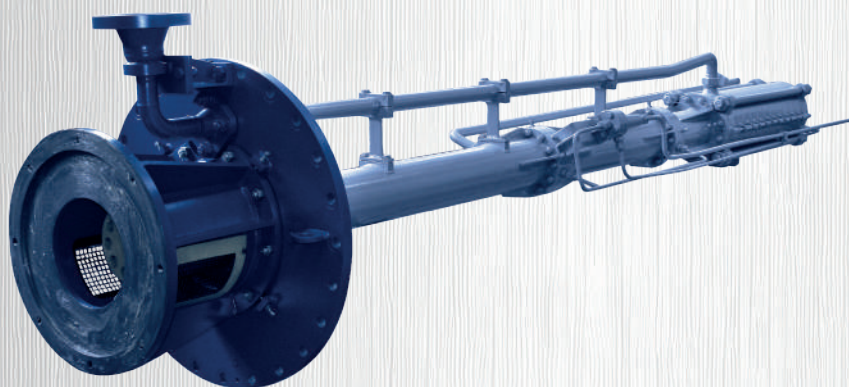
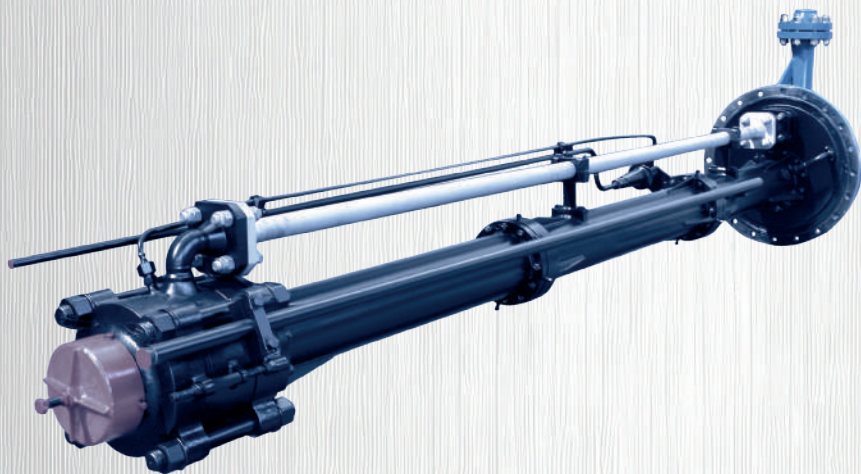

## Model: LCV, HOU

## Type: VS1/2, VS4/5

The pumps are designed for pumping out leakages of oil, petroleum products or other chemically active media from underground tanks and reservoirs. They are manufactured in explosion-proof version and equipped with explosion-proof electric motors. Suitable for outdoor installation. Centrifugal, vertical, semi-submersible, process, modular design. With closed impellers. With single or double mechanical seals. Upper bearings - ball bearings, lower

bearings - sliding bearings on the pumped medium. Pumps can be mounted on the vessel (tank) neck or supplied with their own outer casing (can).



## Application: Horizontal Condensate Pumps

No	Pump size	Rated flow, m <sup>3</sup> /hr	Hmin, m	Hmax, m
1	Ks 32	32	50	200
2	Ks 50	50	50	200
3	Ks 80	80	50	200
4	Ks 1500	1500	200	250
5	KsD 125	125	100	150
6	KsD 140	140	100	150
7	KsD 230	230	80	120

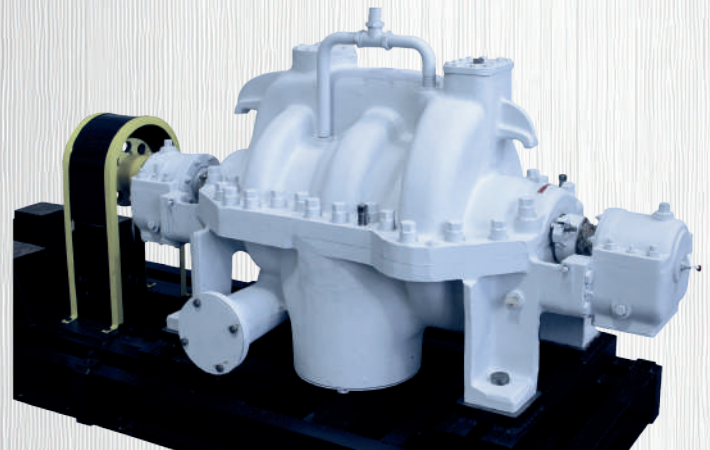
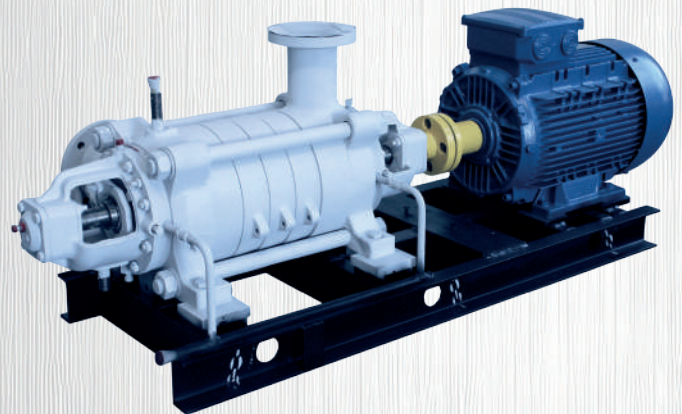

## Model: Kc, KcD Type: BB3 and BB4

### Design:

**Kc** - multistage ring section centrifugal pumps between bearings, with inducer and single entry impeller or impellers arranged one behind the other. Rotor axial thrust balancing by drum. The pump rotor is carried by the antifriction bearings (medium-lubricated internal plain bearings in case of KCr pump). Rotor axial thrust balancing by balance disc and balance disc seat Shaft sealing: packed glands or mechanical seals.

**Kc 1500-240-2:** horizontal centerline-mounted, single-stage axially split volute casing centrifugal

pump with a double suction impeller and horizontal nozzles located opposite inline. sealing: by single mechanical seals.

**KcD:** horizontal multistage, axially split, volute-casing centrifugal pumps, between bearings, with the first-stage double-entry impeller and single-entry radial impellers in back-to-back arrangement. The pump rotor is carried by the anti-friction bearings. Shaft sealing: soft packed glands or mechanical seals.

Application:  
Hot Water Supply Pumps.  
Municipal Central Heating Systems.

No	Rated flow, m <sup>3</sup> /hr	Hmin, m	Hmax, m
1	500	50	70
2	800	50	100
3	1 200	40	140
4	1 600	50	120
5	2 000	50	180
6	2 500	50	180
7	5 000	50	160

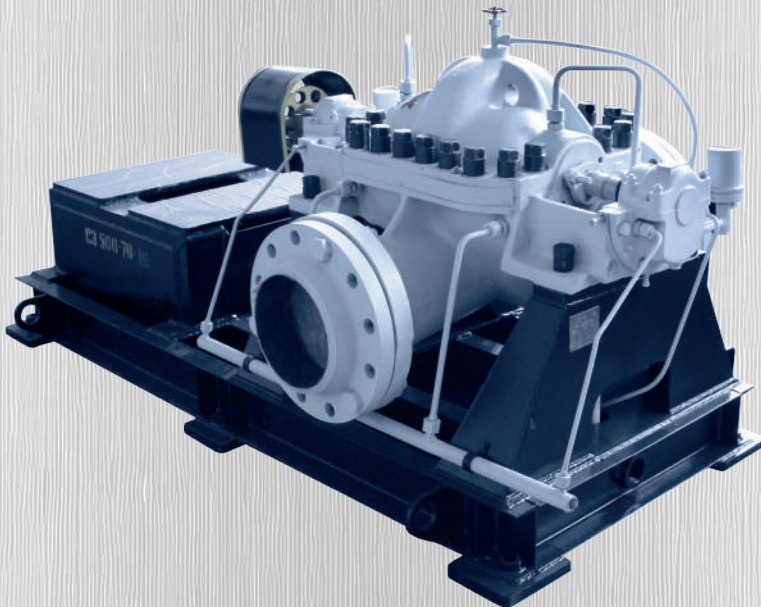
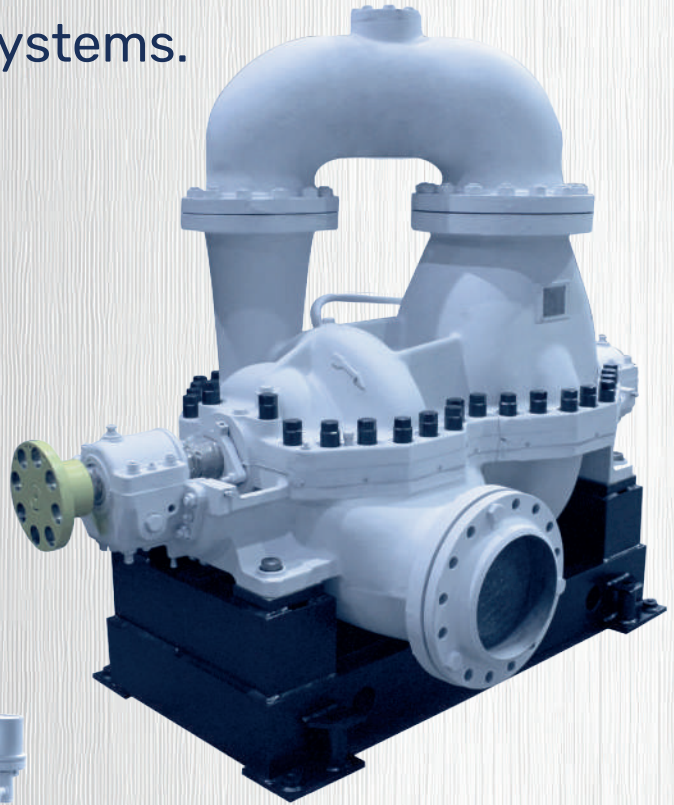

## Model: SE

## Type: BB3 and BB1

**Design:** horizontal single stage or two-stage (with an interstage crossover for CЭ 800-100-11, CЭ 1250-140-11) axially split volute process centrifugal pumps between bearings, with one or two (in case of two-stage pumps) double entry radial impellers. Semicenterline casing support. The pump rotor is carried by the oil-ring or pressure lubricated plain or antifriction bearings. Shaft sealing: packed glands or mechanical seals



Application:  
Water supply. Irrigation.  
Fire pumps.

No	Rated flow, m <sup>3</sup> /hr	Hmin, m	Hmax, m
1	300	80	180
2	400	80	220
3	600	300	400
4	800	120	200
5	1 000	150	220
6	3 000	150	220

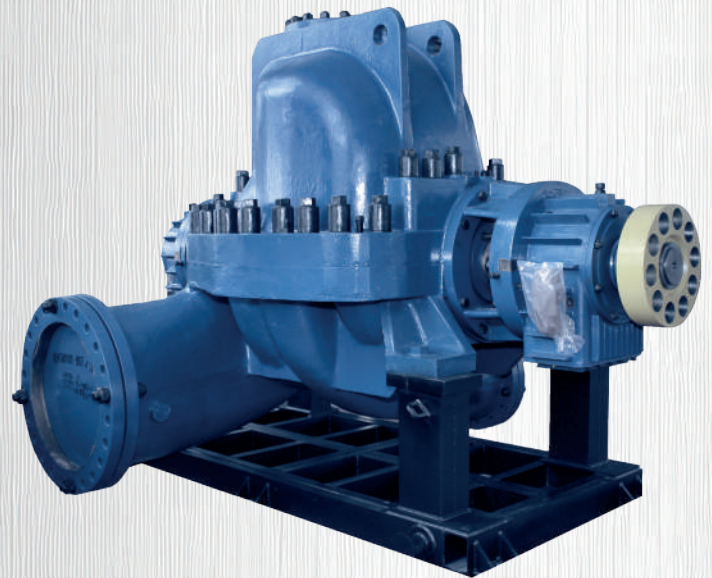
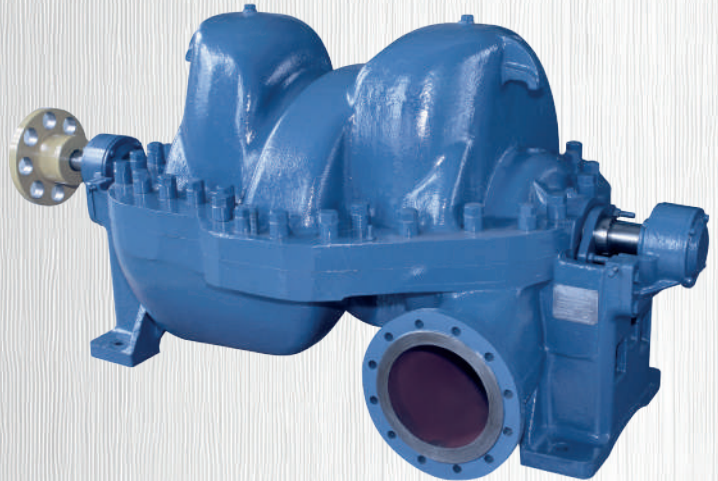

## Model: CN

## Type: BB3 and BB1

**Design:** horizontal foot-mounted, cross-over, two-stage or four-stage, axially split volute casing centrifugal pumps between bearings, with single entry radial impellers mounted back-to-back. Driven by an electric motor or a diesel engine. The rotor is carried by grease-lubricated antifriction bearings. Shaft sealing: packed glands.

**Application:**  
**Water supply.**  
**Irrigation**

No	Rated flow, m <sup>3</sup> /hr	Hmin, m	Hmax, m
1	630	60	130
2	1 200	40	130
3	1 600	40	100
4	2 000	10	100
5	2 500	40	70
6	3 200	15	80
7	4 000	20	120
8	5 000	15	90
9	6 300	10	80
10	12 500	10	30

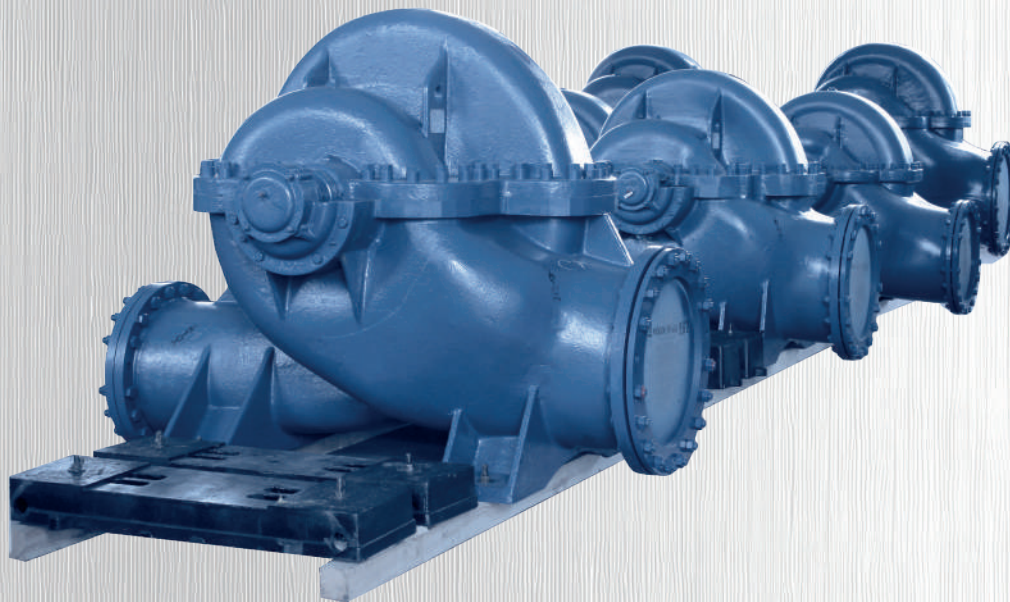

# Model: D

## Type: BB1

**Design:** horizontal foot-mounted, between-bearings, single-stage, axially split volute casing centrifugal pumps with a double suction radial impeller. The rotor is carried by grease-lubricated or oil-ring lubricated (in case of D 6300-80-2 model pump) antifriction bearings. Shaft sealing: packed glands or mechanical seal.



Pump name (old)	Efficiency, %	Pump name (new)	Efficiency, %	Energy Saving (for 6000 hours), kW/h
20Д-6 (Д 2000-100)	75	Д 2000-100-2	82	352 000
20НДН (Д 3200-33)	88	Д 3200-33-2	90	42 000
20НДС (Д3200-75)	87	Д 3200-75-2	88,5	78 000
22НДС (Д 4000-95)	88	Д 4000-95-2	88,5	38 400
24НДН, 32Д-19 (Д 6300-27)	79	Д 6300-27-3	90	429 000
24НДС (Д 6300-80)	88	Д 6300-80-2	88,5	50 400

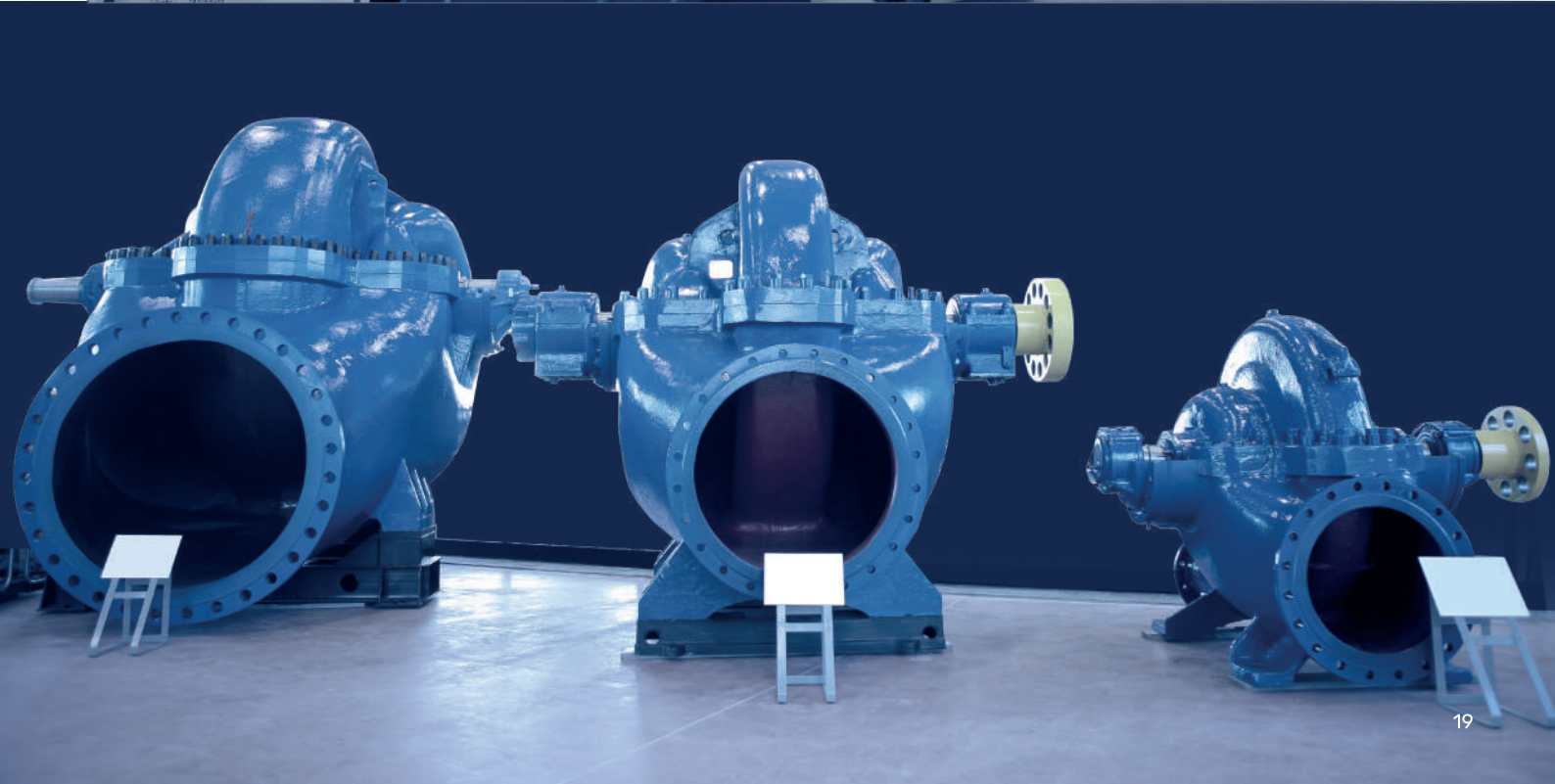

Application:  
Oil and oil products.  
Booster pumps.  
Low pressure oil pumps

No	Rated flow, m <sup>3</sup> /hr	Hmin, m	Hmax, m
1	630	60	150
2	800	60	150
3	1200	40	150
4	1600	40	150
5	2000	40	160
6	2500	40	160
7	3000	40	160
8	4000	40	120

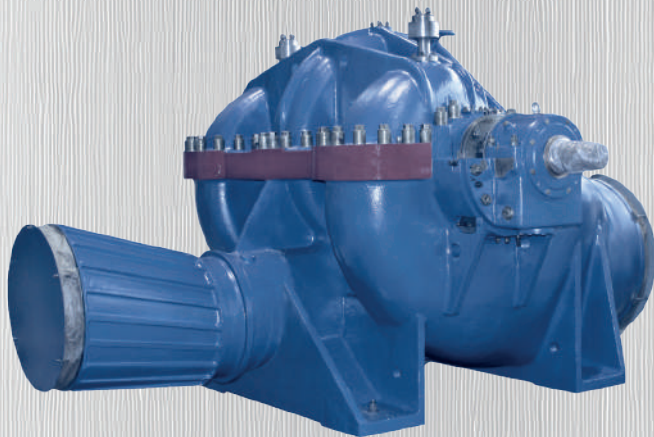

Application:  
Oil and oil products.  
Mainline pumps.

No	Rated flow, m <sup>3</sup> /hr	Hmin, m	Hmax, m
1	1250	150	280
2	1700	150	300
3	2500	150	250
4	3600	150	250
5	5000	150	250
6	7000	150	230
7	10000	150	230
8	12000	150	400
n=3000rpm			



## Model: NCN-E, NGPN-M, NDSN Type: BB1

**Design:** horizontal foot-mounted, between-bearings, single-stage, axially split volute casing centrifugal pumps with a double suction radial impeller and an inducer on each side to reduce the NPSH value. Rotor radial forces are taken up by the radial antifriction bearings with self-contained oil-ring lubrication. The residual axial thrust of the rotor is absorbed by two single row angular-contact antifriction bearings mounted back to back.

## Model: HM

**Design:** horizontal foot-mounted, between-bearings, single-stage, axially split volute casing centrifugal pumps with a double suction radial impeller. The rotor is carried by the pressure oil lubricated sleeve bearings. The residual rotor axial thrust is absorbed by an angular-contact ball bearing (optional hydrodynamic axial plain bearing).





[infopump@elit-oil.com.ua](mailto:infopump@elit-oil.com.ua)  
[info@humelitoil.com](mailto:info@humelitoil.com)

[www.humelitoil.com](http://www.humelitoil.com)

2025-01

